

Star stylus
Sternförmiger Taststift
Styleret en forme d'étoile

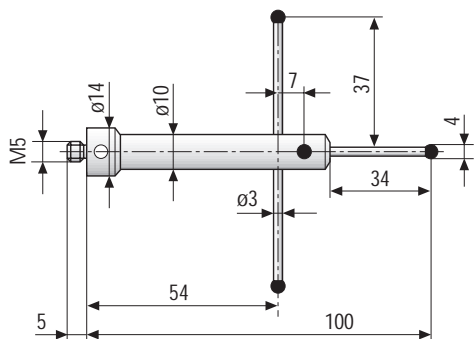

Leitz Nr.	Artikel Nr.
060 - 694.011	42092-9110.00

Styli with ruby ball and tungsten carbide shaft
Taststifte mit Rubinkugel und Hartmetallschaft
Stylets avec bille en rubis et tige en métal dur

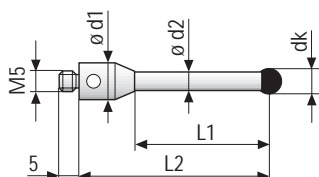

dk	L1	L2	ø d1	ø d2	Leitz Nr.	Artikel Nr.
3	24	35	12	2	060-694.050	42092-9120.00
3	39	50	12	2	060-694.051	42092-9121.00
4	42	55	12	3	999-000.000-496	42992-999-496
5	50	61	12	3,5	060-694.053	42092-9122.00
5	65	80	14	3,5	060-694.052	42092-9126.00
5	70	80	12	3,8	060-694.054	42092-9123.00
8	74	90	12	6	060-694.056	42092-9124.00
8	109	125	12	6	060-694.057	42092-9125.00

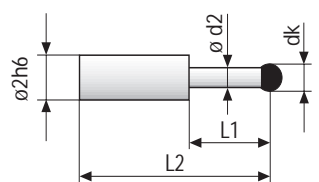

dk	L1	L2	ø d2	Leitz Nr.	Artikel Nr.
0,3	2	15	0,2	-	42088-9129.00
0,5	2	15	0,3	-	42088-9130.00
0,6	4	15	0,4	-	42088-9131.00
0,8	4	15	0,6	-	42088-9132.00
1	4	15	0,8	-	42088-9133.00
1,5	9	21	1,2	060-694.066	42088-9128.00
2	9	21	1,5	060-694.065	42088-9127.00

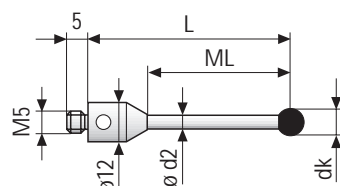

dk	L	ML	ø d2	Artikel Nr.
2	30	18,5	1,5	42992-694150.07
2	35	23,5	1,5	42992-694150.08
2	40	28,5	1,5	42992-694150.09
2	41	30	1,5	42992-694150.13
3,5	91	80	3	42992-694150.05
8	176	160	6	42992-694150.14

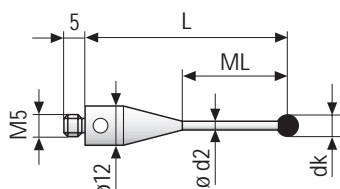

dk	L	ML	ø d2	Artikel Nr.
1,5	40	19	1	42992-694150.10
2	40	19,5	1,5	42992-694150.11
2	60	39,5	1,5	42992-694150.12

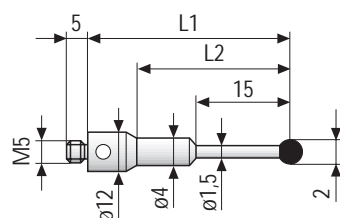

L1	L2	Artikel Nr.
66	56	42992-694150.06
40	32,5	42992-694150.15

Styli with ruby ball and ceramic stem
Taststifte mit Rubinkugel und Keramikschaft
Stylet avec bille rubis et tige en céramique

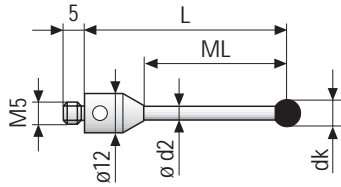

dk	L	ML	ø d2	Leitz-Nr.	Artikel Nr.
8	125	109	6	060-813.041-000	42091-9125.00
8	90	74	6	060-813.042-000	42091-9124.00
15	90	74	6	M00-694-186-000	42986-694186.05

Disc styli
Scheibenförmige Taststifte
Disques de palpae

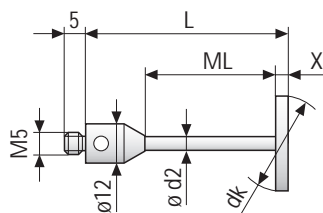

dk	L	ML	ø d2	x	Material	Artikel Nr.
10	46	35	3	0,7	Ruby*	42992-694152.10
8	56	45	2,5	1	Ruby*	42992-694152.11
16	57,5	46,5	3,5	2,5	Ceramic**	42986-694152.12

* Ruby / Rubín / Rubis ** Ceramic / Keramik / Céramique

Styli with tungsten carbide shaft
Taststifte mit Hartmetallschaft
Stylets avec tige en métal dur

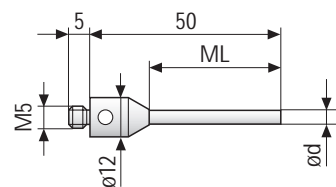

ød	ML	Leitz Nr.	Artikel Nr.
3	39	060-694.152-008	42995-694152.08
5	40	060-694.152-009	42995-694152.09

Styli with ruby ball and tungsten carbide shaft
Taststifte mit Rubinkugel und Hartmetallschaft
Stylets avec bille en rubis et tige en métal dur

Leitz Nr.	Artikel Nr.
060-694.151-005	42988-694151.05

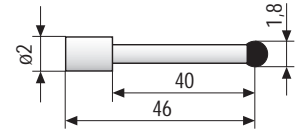

Leitz Nr.	Artikel Nr.
060-694.151-006	42988-694151.06

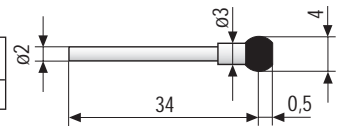

Leitz Nr.	Artikel Nr.
060-694.151-007	42988-694151.07

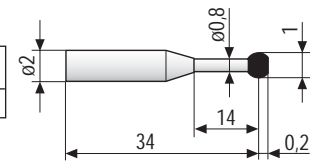

Leitz Nr.	Artikel Nr.
060-694.151-009	42988-694151.09

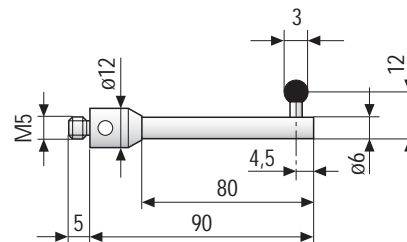
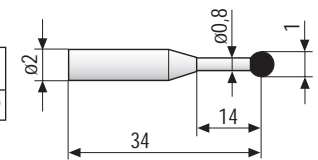

Leitz Nr.	Artikel Nr.
060-694.152-006	42992-694152.06

Star stylus
Sternförmiger Taststift
Stylet en forme d'étoile

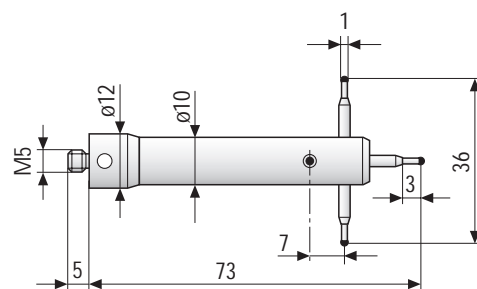

Leitz Nr.	Artikel Nr.
060-694.152-007	42992-694152.07